

General Electric Company

Schenectady, N.Y.

MAY, 1924

*BULLETIN NO. 54633.1A

PARTS OF TYPE K-36 FORM JR CONTROLLER

Cat. No.	No. Req.	Description
141687	1	MAIN HANDLE
189499	1	REVERSE HANDLE
261753	1	FRAME with bearing cap, cap screws, pivot and stop pins
235003	1	Bearing cap for main cylinder shaft bearing, with pivot and stop pins
143997	2	Cap screw fastening bearing cap to frame (3/8 in.-16, 1 1/4 in. hex.h. slot., sherardized)
154197	2	Spring lock washer for No. 143997 (13/32 in. by 25/32 in. by 3/32 in. thick)
1468330	1	Oil pipe for main cylinder shaft bearing
113182	1	Cap plate with bushing for main cylinder shaft bearing
442783	1	Bushing for cap plate and main cylinder shaft bearing
30520	1	Set screw for bushing (5/16 in.-18, 5/16 in. headless, pointed, sherardized)
144972	4	Cap screw fastening cap plate to frame (3/8 in.-16, 7/8 in. hex.h. sherardized)
127064	1	Water cap and pointer for main cylinder shaft, with set screw
127065	1	Water cap for reverse cylinder shaft, with set screw
14410	2	Set screw for water cap (5/16 in.-18, 5/8 in. headless, pointed, sherardized)
113184	1	Wooden cover
435529	1	Catch for cover, right-hand
432843	1	Catch for cover, left-hand
112029	2	Stud for catch (3/8 in.-16, 1 13/32 in. long)
2402352	2	Thumbnut for stud (3/8 in.-16, tap)
143974	2	Washer for stud (17/64 in. by 1/2 in. by 0.0625 in. sherardized)
235004	1	ARC DEFLECTOR
1432654	1	Wide strip for arc deflector
110088	1	Narrow strip for arc deflector

NOTE:- Data subject to change without notice.

*Supersedes Bulletin No. 54633.1

PARTS OF TYPE K-36 FORM JR CONTROLLER

Cat.No.	No. Req.	Description
110082	1	Upper end arcing plate for arc deflector
110083	1	Lower end arcing plate for arc deflector
110085	10	Arcing plate for arc deflector except end arcing plates
1432627	8	ARC SUPPRESSOR PLATE
17678	24	Screw fastening narrow strip to arcing plate (No. 10, 1 in. r.h. blued)
121834	40	Screw fastening wide strip to arcing plate or arc suppressor plate (No. 10, 7/8 in. f.h. sherardized)
235005	1	Upper hinge bracket with hinge pin
235006	1	Lower hinge bracket with hinge pin and latch
206771	1	Latch for arc deflector
407714	1	Hinge pin for latch
110774	2	Spring cotter for hinge pin (3/32 in. by 5/8 in. sherardized)
206772	1	Compression spring for latch
143510	4	Screw fastening wide strip to hinge bracket (5/16 in. -18, 5/8 in. r.h. sherardized)
145670	4	Screw fastening narrow strip to hinge bracket (5/16 in. -18, 7/8 in. r.h. sherardized)
235007	1	MAIN CYLINDER with shaft, star wheel, insulation disk, collar and contact segments
220064	1	Set of copper contact segments
1495605	3	Contact segment
1495615	3	Contact segment
1496910	3	Contact segment
1495603	2	Contact segment
1495612	2	Contact segment
1495258	2	Contact segment
1495606	1	Contact segment
1495614	1	Contact segment
1464827	8	Burning tip
400037	34	Segment screw
For illustrations of contact segments see pages 4 and 5.		
1886833P22	1	Insulated hexagonal shaft
113190	1	Cylinder casting, upper
113191	1	Cylinder casting, middle
113192	1	Cylinder casting, lower
435887	2	Clamping spring for No. 113190

PARTS OF TYPE K-36 FORM JR CONTROLLER

54633.1A-3

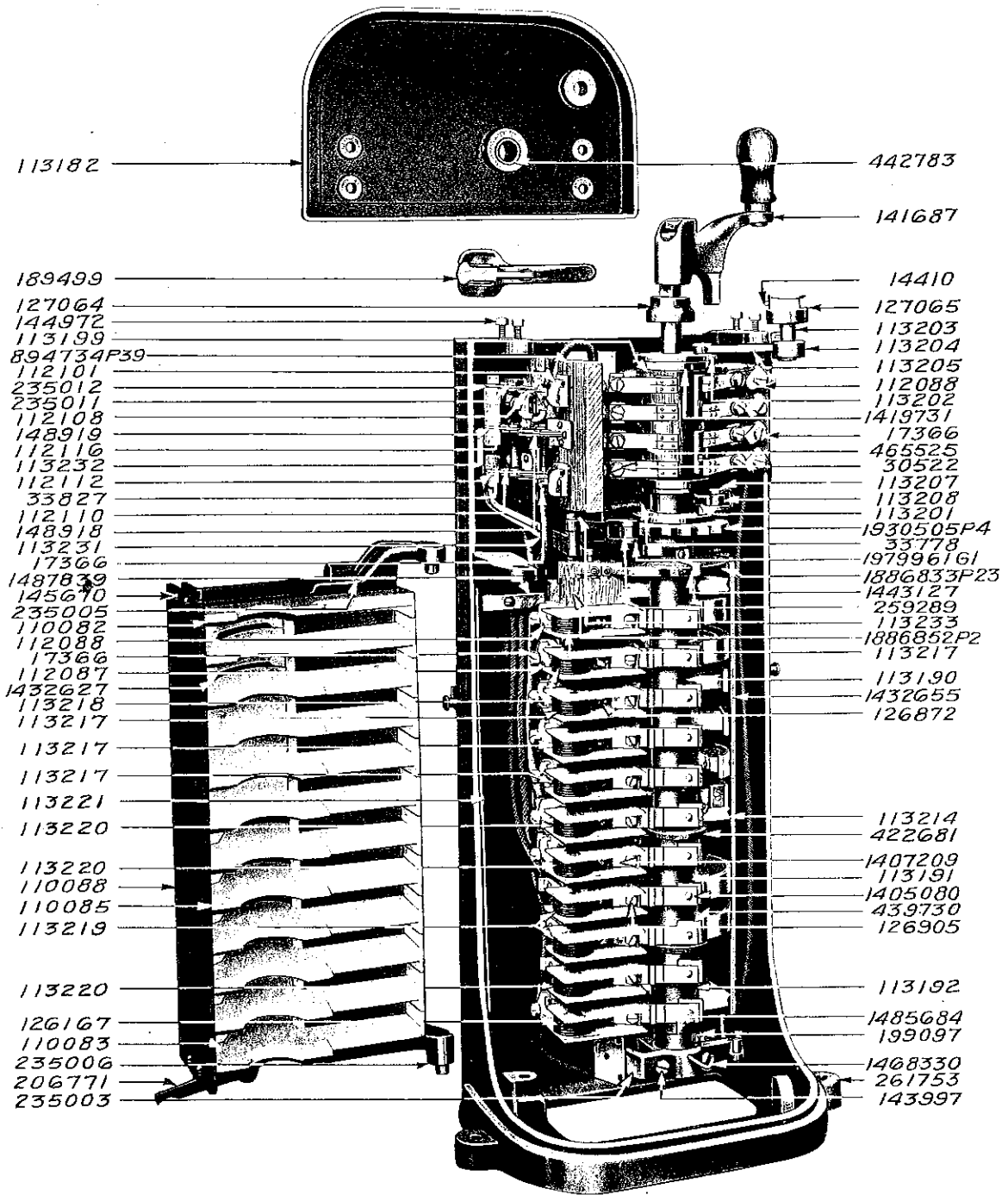

Type K-36 Form JR Controller

PARTS OF TYPE K-36 FORM JR CONTROLLER

Cat.No.	No. Req.	Description
113193	1	Clamping spring for No. 113191
435385	1	Clamping spring for No. 113192
111111	6	Set screw for clamping spring
422681	4	Spacing disk between cylinder castings
460329	8	Felt washer between spacing disks and cylinder casting (1 9/16 in. by 2 1/8 in. by 1/16 in. thick)
1930505P3	1	STAR WHEEL

MAIN CYLINDER SEGMENTS

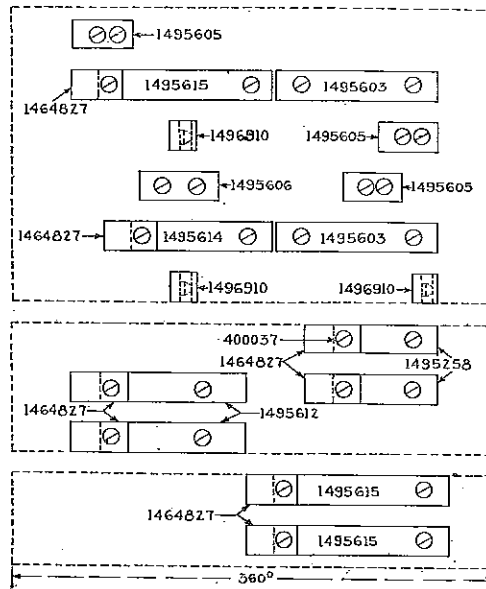

402114	1	Pin for star wheel
1886833P4	1	Insulation disk
1443127	1	Contact segment for insulation disk
175561	1	Screw fastening segment to insulation disk (10-30, 1/2 in. r.h. sherardized)
150279	1	Washer for No. 175561 (13/64 in. by 13/32 in. by 0.044 in. sherardized)
154191	1	Spring lock washer for No. 175561 (13/64 in. by 25/64 in. by 0.0625 in.)
1485684	1	Collar for shaft
199097	1	Set screw for collar
422515	1	Insulation spacing collar between lower cylinder casting and steel collar

PARTS OF TYPE K-36 FORM JR CONTROLLER

54633.1A-5

MAIN CYLINDER SEGMENTS (ACTUAL SIZE)

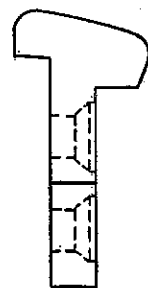
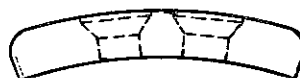
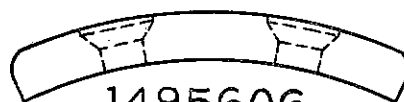
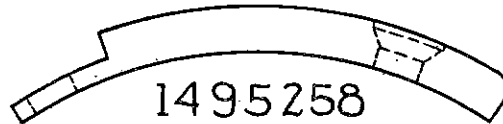
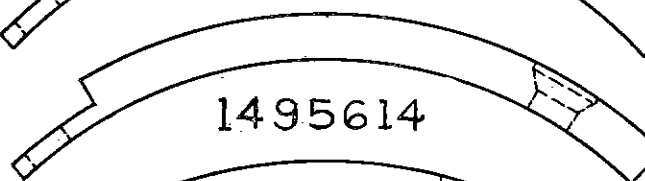
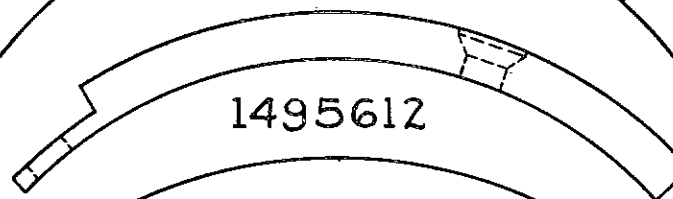
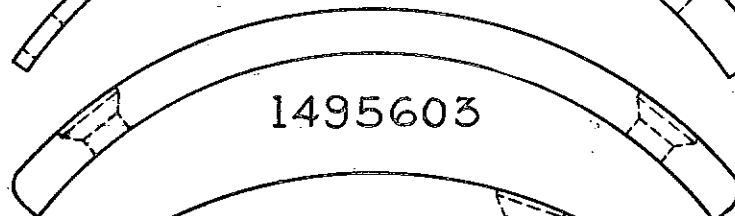
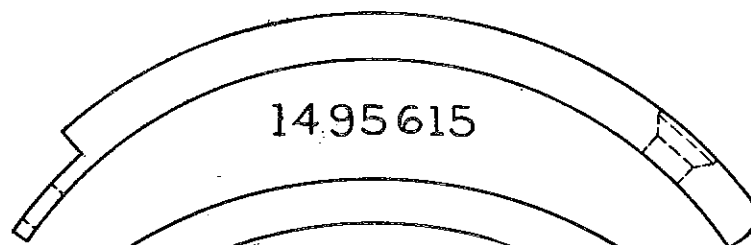

PARTS OF TYPE X-36 FORM JR CONTROLLER

Cat.No.	No. Req.	Description
400037	1	Retaining screw for oil wick
1979961G1	1	Check pawl with roller and spring post, for main cylinder
259289	1	Roller with pin
40257	1	Pivot pin for check pawl
110774	2	Spring cotter for pivot pin (3/32 in. by 5/8 in. sherardized)
33778	1	Tension spring for check pawl
33779	1	Spring post for tension spring
113198	1	REVERSE CYLINDER with insulation disks, operating disk and star wheel
113199	1	Cylinder body
1419731	1	Insulation disk
113201	1	STAR WHEEL
113202	1	Operating disk with pin
127349	7	Screw fastening operating disks to cylinder body and short screw fastening star wheel to cylinder body (No. 10, 1 in. f.h. sherardized)
179622	1	Long screw fastening star wheel to cylinder body (No. 10, 1 1/2 in. f.h. sherardized)
69072	1	Set of copper contact segments with screws
1467882	4	Small contact segment
66905	2	Large contact segment
153979	14	Screw fastening contact segment to cylinder body (No. 8, 3/4 in. f.h. sherardized)
1435236	2	Fiber filler strip
113203	1	Operating shaft for reverse cylinder
113204	1	Operating arm with pin, for operating shaft
113205	1	Link for operating arm and disk
113206	1	Pin for link and operating arm
141259	1	Washer for pin (13/32 in. by 3/4 in. by 0.0625 in. sherardized)
110774	2	Spring cotter for pin (3/32 in. by 5/8 in. sherardized)
113207	1	Interlocking pawl with roller
113208	1	Roller with pin
113209	1	Pivot pin for interlocking pawl
161261	1	Washer for pivot pin (15/32 in. by 7/8 in. by 0.0625 in. sherardized)
110774	1	Spring cotter for pivot pin (3/32 in. by 5/8 in. sherardized)
113210	1	Tension spring for interlocking pawl
33779	1	Spring post for tension spring

PARTS OF TYPE K-36 FORM JR CONTROLLER

Cat.No.	No. Req.	Description
225008	1	Insulation trough for main cylinder
1432655	1	Side plate for trough, right-hand
113213	1	Side plate for trough, left-hand
1435000	1	Back plate for trough
113214	4	Arcing plate for trough
153184	20	Screw fastening side plate or back plate to arcing plates (No. 8, 7/8 in. f.h. sherardized)
127116	3	Screw fastening insulation trough to frame (14-24, 5/8 in. r.h. sherardized)
144066	1	Screw fastening insulation trough to frame (14-24, 5/8 in. f.h. sherardized)
154194	3	Spring lock washer for No. 127116 (17/64 in. by 29/64 in. by 5/64 in. thick)
235009	1	MAIN FINGER BLOCK with finger bases, blowout coils and contact fingers
235010	1	Main finger block with finger bases and blowout coils, without contact fingers
1886852P2	1	Finger block
113217	4	BLOWOUT COIL with pole pieces, finger base and terminal block, for 1st, 3rd, 4th or 5th finger
113218	1	Blowout coil with pole pieces, finger base and terminal block, for 2nd finger
113220	3	Blowout coil with pole pieces, finger base, terminal block and terminal strip, for 6th, 7th or 10th finger
113219	2	Blowout coil with pole pieces, finger base, and terminal strip, for 8th or 9th finger
126167	1	Blowout coil with pole pieces, finger base, terminal block and terminal strip, for 11th finger
112088	7	Terminal clamp for Nos. 113217, 113220
112087	2	Terminal clamp for Nos. 113218, 126167
17366	9	Clamping screw for Nos. 112088, 112087 (5/16 in.-18, 7/8 in. hex.h. slot., sherardized, cap screw)
112090	2	Terminal strip with rivets, for No. 113219
48160	2	Screw fastening No. 112090 to finger block (No. 10, 1/2 in. r.h. blued)
153984	9	Screw fastening contact base to finger block and long screw fastening terminal block to finger block No. 10, 1 1/4 in. f.h. sherardized)

PARTS OF TYPE K-36 FORM JR CONTROLLER

Cat.No.	No. Req.	Description
127347	9	Short screw fastening terminal to finger block (No. 10, 3/4 in. f.h. sherardized)
1405080	11	MAIN CONTACT FINGER
439730	11	Contact tip
126905	11	Adjusting screw for contact finger (14-24, 5/8 in. hex.h. slot., sherardized, cap screw)
1407209	11	Locking spring for No. 126905
126872	11	Cap screw fastening contact finger to base (5/16 in.-18, 5/8 in. hex.h. slot., sherardized)
498560	11	Washer for No. 126872 (21/64 in. by 5/8 in. by 0.0625 in. sherardized)
154196	11	Spring lock washer for No. 126872 (21/64 in. by 37/64 in. by 5/64 in. thick)
148915	3	Screw fastening finger block to frame (5/16 in.-18, 2 in. r.h. sherardized)
498560	3	Washer for No. 148915 (21/64 in. by 5/8 in. by 0.0625 in. sherardized)
113221	1	Insulation between main finger block cables and frame
1487839	2	Cleat for cables
19628	4	Screw fastening cleat to finger block (No. 10, 1 1/2 in. r.h. blued)
148916	1	REVERSE FINGER BLOCK, right-hand, with finger bases, and contact fingers
148917	1	REVERSE FINGER BLOCK, left-hand, with finger bases, and contact fingers
113222	1	Reverse finger block, right-hand, with finger bases, without contact fingers
113223	1	Reverse finger block, left-hand, with finger bases, without contact fingers
113224	1	Finger block, right-hand
113225	1	Finger block, left-hand
113226	4	Finger base for No. 148916
113227	4	Finger base for No. 148917
112088	8	Terminal clamp for finger base
17366	8	Clamping screw for clamp (5/16 in.-18, 7/8 in. hex.h. slot., sherardized cap screw)
121834	16	Screw fastening finger base to finger block (No. 10, 7/8 in. f.h. sherardized)
465525	8	REVERSE CONTACT FINGER
30522	8	Cap screw fastening contact finger to base (5/16 in.-18, 1/2 in. hex.h. slot., sherardized)

PARTS OF TYPE K-36 FORM JR CONTROLLER

54633.1A-9

Cat.No.	No. Req.	Description
498560	8	Washer for No. 30522 (21/64 in. by 5/8 in. by 0.0625 in. sherardized)
143973	6	Screw fastening finger block to frame (14-24, 1 1/2 in. r.h. sherardized)
143974	6	Washer for No. 143973 (17/64 in. by 1/2 in. by 0.0625 in. sherardized)
144978	1	Ground terminal for main and reverse finger block cable
151712	2	Screw fastening No. 144978 to frame (14-24, 5/16 in. r.h. sherardized)
154194	2	Spring lock washer for No. 151712 (17/64 in. by 29/64 in. by 5/64 in. thick)
224942	1	MOTOR CUTOFF SWITCH with insulated cables
894734P39	1	Wooden base
112108	2	Switch contact with terminal block
148918	1	Switch contact with terminal block
112110	1	Switch contact with ground connection
235011	1	Double switch contact with terminal block
235012	1	Switch blade with fulcrum and terminal block
148919	1	Switch blade with fulcrum, middle
112112	1	Switch blade with fulcrum, lower
411352	2	Switch blade for No. 112112 or 235012
411441	1	Switch blade for No. 148919
449784	3	Pivot pin for switch blade
411353	6	Spring washer for pivot pin
894734P43	1	Connection strip for Nos. 235011, 235012
112101	2	Terminal clamp for No. 112108
112088	1	Terminal clamp for No. 235012
498933	1	Terminal for No. 235011
17366	2	Clamping screw for No. 112101 (5/16 in. -18, 7/8 in. hex.h. slot., sherardized, cap screw)
33827	1	Single switch handle with fiber collar
112116	1	Double switch handle
39546	6	Screw fastening No. 148918, 112110, 235011, 235012, 148919 or 112112 to wooden base and short screw fastening No. 112108 to wooden base (No. 10, 3/4 in. r.h. blued)
51400	13	Long screw fastening No. 112108 to wooden base (No. 10, 7/8 in. r.h. blued)
206765	4	Screw fastening wooden base to reverse finger block (No. 12, 1 3/4 in. f.h. sherardized)
112305	2	Cap screw fastening ground connection for No. 112110 to frame (14-24, 1/2 in. hex. h. slot., sherardized)

PARTS OF TYPE K-36 FORM JR CONTROLLER

Cat.No.	No. Req.	Description
30523	1	Washer plate for No. 112305
113231	1	Series stop lever with fiber shoe and spring post
113232	1	Fiber shoe
148921	2	Screw fastening shoe to lever (14-24, 1/2 in. f.h. sherardized)
113233	1	Pivot pin for series stop lever
110774	2	Spring cotter for No. 113233 (3/32 in. by 5/8 in. sherardized)
113234	1	Tension spring for series stop lever
33779	1	Spring post for tension spring
14963	2	Bracket with one bolt hole, fastening controller to dash
153940	2	Bracket with two bolt holes, fastening controller to dash
150854	2	Cap screw fastening bracket to controller (1/2 in.-13, 1 in. hex.h. sherardized)
414756	2	Washer for No. 150854 (17/32 in. by 1 3/8 in. by 0.094 in. sherardized)
17789	2	Dowel for feet of controller, with nut
1480738	2	Nut for No. 17789 (1/2 in.-13, hex. st'd, sherardized)

RATCHET SWITCH

221257	1	Set of parts necessary to equip a Type K-36 Form P Controller for auxiliary line breaker operation
--------	---	----------------------------------------------------------------------------------------------------

Following are the parts:-

1400404	1	Finger base
153979	2	Screw fastening finger base to finger block (No. 8, 3/4 in. f.h. sherardized)
1404009	1	CONTACT FINGER
417591	1	Copper terminal for contact finger
1404010	1	Support for copper terminal
166096	1	Screw fastening contact finger to finger base (10-30, 3/8 in. r.h. sherardized)
175561	1	Screw fastening contact finger and copper terminal to finger base (10-30, 1/2 in. r.h. sherardized)
150279	1	Washer for No. 175561 (13/64 in. by 13/32 in. by 0.044 in. sherardized)
154191	2	Spring lock washer for No. 166096 or 175561 (13/64 in. by 25/64 in. by 0.0625 in.)
216827	1	RATCHET MECHANISM, consists of top and bottom plates, ratchet wheel, set screw, ratchet pawls, tension spring, copper contact, contact support and star wheel segment

PARTS OF TYPE K-36 FORM JR CONTROLLER

54633.1A-11

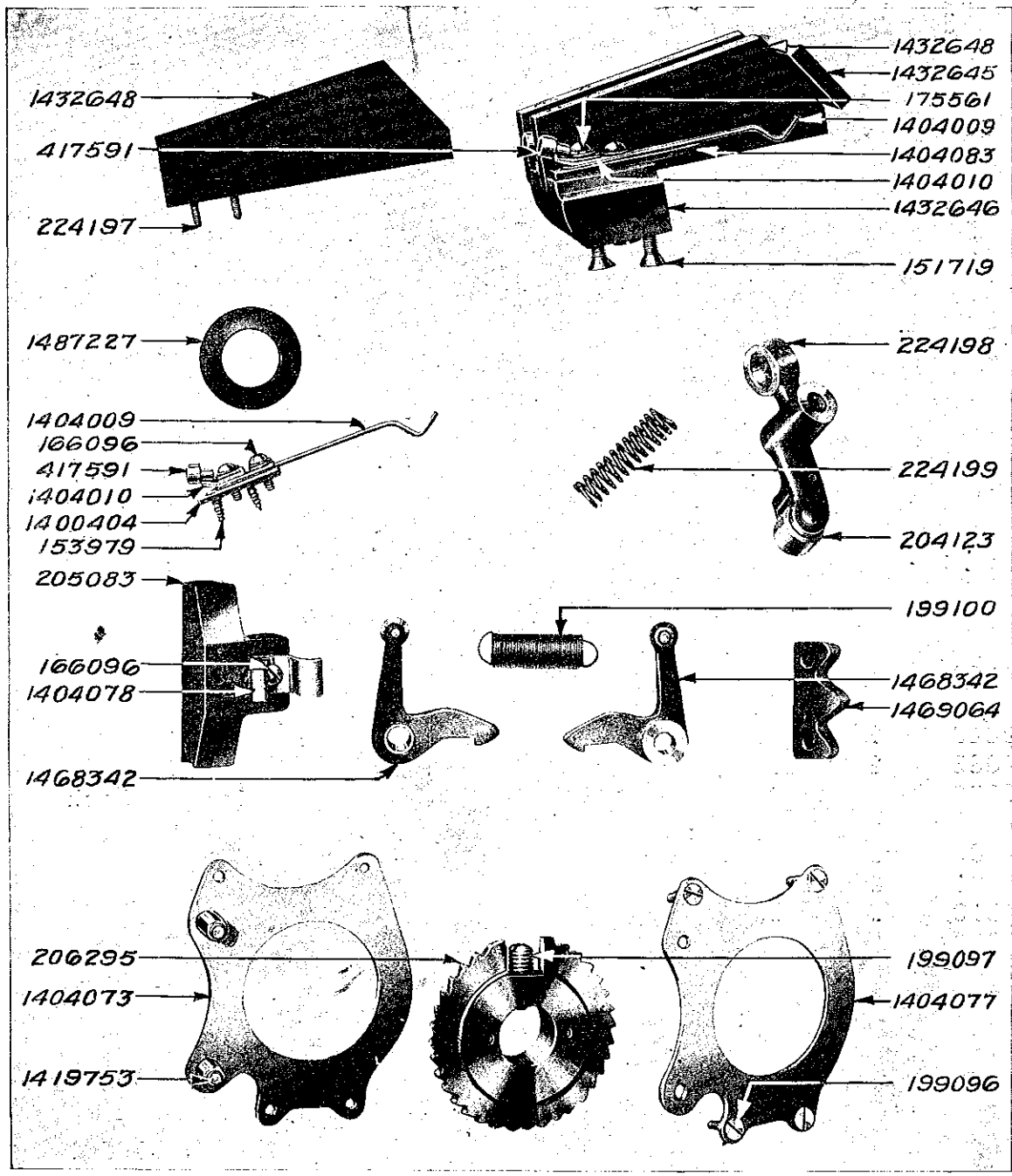

RATCHET SWITCH

PARTS OF TYPE K-36 FORM JR CONTROLLER

Cat.No.	No. Req.	Description
206295	1	Ratchet wheel
199097	1	Set screw for ratchet wheel (7/16 in.-14, 1 1/32 in. headless, sp'l, sherardized)
1404073	1	Top plate for ratchet wheel
1404077	1	Bottom plate for ratchet wheel
1468342	2	Pawl for ratchet wheel, with bushing and spring post
1419753	2	Pivot pin for pawl
199100	1	Tension spring for pawls
1469064	1	Star wheel segment
205083	1	Contact support with copper contact
1404078	1	Copper contact
166096	1	Screw fastening contact to support (10-30, 3/8 in. r.h. sherardized)
154191	1	Spring lock washer for No. 166096 (13/64 in. by 25/64 in. by 0.0625 in.)
199096	4	Screw fastening star wheel segment, contact support, top and bottom plates together (10-30, 3/4 in. f.h. sherardized)
224195	1	Finger block with finger bases, contact fingers, copper terminals, arcing plates and brace
224196	1	Finger block with finger bases, without fingers
1432646	1	Finger block
1404083	2	Finger base
205086	4	Screw fastening finger base to finger block (8-36, 5/8 in. f.h. sherardized)
1404009	2	CONTACT FINGER
417591	2	Copper terminal
1404010	2	Support for copper terminal
166096	2	Screw fastening contact finger to finger base (10-30, 3/8 in. r.h. sherardized)
175561	2	Screw fastening contact finger and copper terminal to finger base (10-30, 1/2 in. r.h. sherardized)
150279	2	Washer for No. 175561 (13/64 in. by 13/32 in. by 0.044 in. sherardized)
154191	4	Spring lock washer for No. 166096 or 175561 (13/64 in. by 25/64 in. by 0.0625 in.)
1432648	3	Arcing plate
1432645	1	Brace for arcing plates
224197	6	Screw fastening arcing plate to finger block (6-40, 1 in. r.h. sherardized)
205086	3	Screw fastening brace to arcing plate (8-36, 5/8 in. f.h. sherardized)

PARTS OF TYPE K-36 FORM JR CONTROLLER

Cat.No.	No. Req.	Description
151719	2	Screw fastening finger block to bearing cap (14-24, 7/8 in. f.b. sherardized)
1487227	1	Spacing washer between ratchet attachment and bearing cap
224198	1	Check pawl with roller
204123	1	Roller with pin
1487231	1	Pivot pin for check pawl
224199	1	Compression spring for check pawl
161261	1	Washer for pivot pin (15/32 in. by 7/8 in. by 0.0625 in. sherardized)
110774	1	Spring cotter for pivot pin (3/32 in. by 5/8 in. sherardized)

INDEX TO CATALOG NUMBERS

Cat.No.	Page	Cat.No.	Page	Cat.No.	Page	Cat.No.	Page
14410-1		112112-9		113224-8		148918-9	
14963-10		112116-9		113225-8		148919-9	
17366-7-8-9		112305-9		113226-8		148921-10	
17678-2		113182-1		113227-8		150279-4-10-12	
17789-10		113184-1		113231-10		150854-10	
19628-8		113190-2		113232-10		151712-9	
30520-1		113191-2		113233-10		151719-13	
30522-8		113192-2		113234-10		153184-7	
30523-10		113193-4		121834-2-8		153940-10	
33778-6		113198-6		126167-7		153979-6-10	
33779-6-10		113199-6		126872-8		153984-7	
33827-9		113201-6		126905-8		154191-4-10-12	
39546-9		113202-6		127064-1		154194-7-9	
40257-6		113203-6		127065-1		154196-8	
48160-7		113204-6		127116-7		154197-1	
51400-9		113205-6		127347-8		161261-6-13	
66905-6		113206-6		127349-6		166096-10-12	
69072-6		113207-6		141259-6		175561-4-10-12	
110082-2		113208-6		141687-1		179622-6	
110083-2		113209-6		143510-2		189499-1	
110085-2		113210-6		143973-9		199096-12	
110088-1		113213-7		143974-1-9		199097-4-12	
110774-2-6-10-13		113214-7		143997-1		199100-12	
111111-4		113217-7		144066-7		204123-13	
112029-1		113218-7		144972-1		205083-12	
112087-7		113219-7		144978-9		205086-12	
112088-7-8-9		113220-7		145670-2		206295-12	
112090-7		113221-8		148915-8		206765-9	
112101-9		113222-8		148916-8		206771-2	
112108-9		113223-8		148917-8		206772-2	
112110-9							

PARTS OF TYPE K-36 FORM JR CONTROLLER

INDEX TO CATALOG NUMBERS

Cat.No.	Page	Cat.No.	Page	Cat No.	Page	Cat.No.	Page
216827-10		402114-4		1400404-10		1468330-1	
220064-2		407714-2		1404009-10-12		1468342-12	
221257-10		411352-9		1404010-10-12		1469064-12	
224195-12		411353-9		1404073-12		1480738-10	
224196-12		411441-9		1404077-12		1485684-4	
224197-12		414756-10		1404078-12		1487227-13	
224198-13		417591-10-12		1404083-12		1487231-13	
224199-13		422515-4		1405080-8		1487839-8	
224942-9		422681-4		1407209-8		1495258-2	
235003-1		432843-1		1419731-6		1495603-2	
235004-1		435385-4		1419753-12		1495605-2	
235005-2		435529-1		1432627-2		1495606-2	
235006-2		435887-4		1432645-12		1495612-2	
235007-2		439730-8		1432646-12		1495614-2	
235008-7		442783-1		1432648-12		1495615-2	
235009-7		449784-9		1432654-1		1496910-2	
235010-7		460329-4		1432655-7		1886833P22-2	
235011-9		465525-8		1435000-7		1886833P4-4	
235012-9		498560-8-9		1435236-6		1886852P2-7	
259289-6		498933-9		1443127-4		1930505P3-4	
261753-1		894734P39-9		1464827-2		1979961G1-6	
400037-2-6		894734P43-9		1467882-6		2402352-1	

1 3 27

Dist. General Electric Co. Inc.
99237 10.3.21

General Electric Company
 Schenectady, N.Y., U.S.A.

Sales Offices in all principal cities